





EFC 211 Fan Control

USA

CAN



-  **Product Information Chapter 1 + 2**
-  **Mechanical Installation Chapter 3**
-  **Electrical Installation Chapter 4**
-  **Start Up and Configuration Chapter 5**
-  **Maintenance and Troubleshooting Chapter 6**

Job Name: _____

Installer: _____

Installation Date: _____



1. Product Information	
1.1 Product Information.....	3
1.2 Shipping	3
1.3 Warranty.....	3
2. Specifications	
3.1 Dimensions & Capacities	5
3. Mechanical Installation	
4.1 Location.....	6
4. Electrical Installation	
5.1 Terminal Connections.....	7
5. Startup and Configuration	
6.1 Pre-Operation Inspection	8
6.2 Setting the Control	8
6.3 Surveillance.....	8
6.4 Alarm Functions	8

Symbol Legend:

The following terms are used throughout this manual to bring attention to the presence of potential hazards or to important information concerning the product.



Danger: Indicates an imminently hazardous situation which, if not avoided, will result in death, serious injury or substantial property damage.



Caution: Indicates an imminently hazardous situation which, if not avoided, may result in personal injury or property damage.



TO REDUCE THE RISK OF FIRE, ELECTRICAL SHOCK OR INJURY TO PERSONS, OBSERVE THE FOLLOWING:

1. Use this unit in the manner intended by the manufacturer. If you have questions, contact the manufacturer at the address or telephone number listed on the front of the manual.
2. Before servicing or cleaning the unit, switch off at service panel and lock service panel to prevent power from being switched on accidentally.
3. Installation work and electrical wiring must be done by a qualified person(s) in accordance with applicable codes and standards.
4. Follow the appliance manufacturer's guidelines and safety standards such as those published by the National Fire Protection Associations (NFPA), and the American Society for Heating,

Refrigeration and Air Conditioning Engineers (ASHRAE), and the local code authorities.

5. This unit must be grounded.

How to use this manual

This installation manual does not contain any system design documentation. System design documentation is available from any authorized EXHAUSTO representative.

Accessories, fans and variable frequency drives are not covered by this manual. Please refer to these component's individual manuals.



1. Product Information

1.1 Function

Use	<p>The EXHAUSTO EFC211 Fan Control is used with wood-fired heating appliances to monitor and maintain proper draft. This is achieved by maintaining the proper speed of a chimney fan. The EFC 211 is designed for use with EXHAUSTO Models RS or GSV.</p> <p>The intended use of the control includes, but is not limited to:</p> <ul style="list-style-type: none">• Controlling the speed of a chimney fan used with a wood-fired fireplace or stove• Controlling the speed of a chimney fan used with a wood-fired pizza oven in a restaurant kitchen <p>For indoor installation only.</p>
Function	<p>The EFC211 consists of a control box and a speed control unit. The control box is installed on the outside of the chimney or inside an attic. The speed control unit is installed in the room where the heating appliance is located.</p> <p>The fan control should be set to produce the desired fan speed or draft. The chimney fan starts with a 15 second boost to assure proper fan operation. At the same time, the green LED on the control panel will flash. After the 15 seconds, the chimney fan will continue to operate at the set speed.</p> <p>During operation the fan speed can be adjusted using the dial, which is also used to turn the fan on and off. The control constantly monitors the draft in the chimney and, measures the fan speed every minute. If the speed is too low, the control will send a signal to briefly increase the fan speed.</p> <p>If the draft remains inadequate, the fan speed will increase to maximum speed for 15 seconds. During this time the green LED will flash - as it does during start up. If the draft is adequate the chimney fan will continue to operate at the set speed.</p> <p>A green LED flashing during normal operation (after start up) is an indication that the minimum current in the power supply is set too low for the fan to operate. The factory setting for the motor power supply is 65 VAC.</p> <p>If the red LED flashes and the buzzer sounds, it can be caused by:</p> <ul style="list-style-type: none">• Defective chimney fan• Disconnected power supply <p>The control can be reset, and the alarm turned off, by pressing the reset button for 1-2 seconds.</p> <p>When used with a solid-fuel fired appliance a smoke detector shall be installed and maintained in accordance with NFPA72, National Fire Alarm Code.</p>
Listings	<p>Listed to UL378, Standard for Draft Equipment, when used with an EXHAUSTO Chimney Fan, Model RS 009-016. Approved for and meets the requirements of NFPA 211 Standard for Solid-Fuel Chimneys and Fireplaces. Intertek ETL Semko is not endorsing the connection of this controller to any draft fan, exhaust fan that is not of the models mentioned above. This controller model: EFC 211 is only recognized for connection to the above models that are manufactured by Exhausto Inc. as mentioned in the above paragraph and bearing the ETL mark for Canada and the USA. Use with a fan installed in a Solid Fuel Burning Appliance has not been proven to meet safety compliance.</p>

1.2 Shipping

The EFC 211 contains the following:

- Control box
- Speed Control Unit
- User manual

1.3 Warranty

Complete warranty conditions are available from EXHAUSTO, Inc.

EFC 211 Control Components

The EFC 211 control is built up around a main control units that controls all basic functions.

The main control units controls the draft or exhaust function. It is connected directly to the power supply and feeds power to the chimney fan.

The main control unit is shown below in Fig. 1:

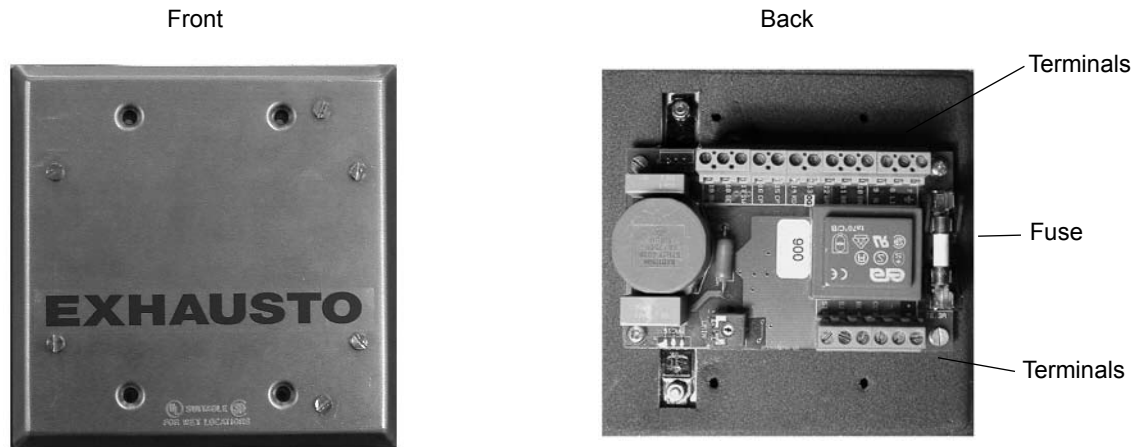

Fig. 1

The front panel serves as a cover for a 4x4 junction, while the control unit is mounted on the back of the cover. The board contains the wiring terminals as well as the triac used to control the speed of the chimney fan. The board is protected by a fuse.

The speed control unit is connected to the main control unit . The speed control unit is shown below in Fig. 2:

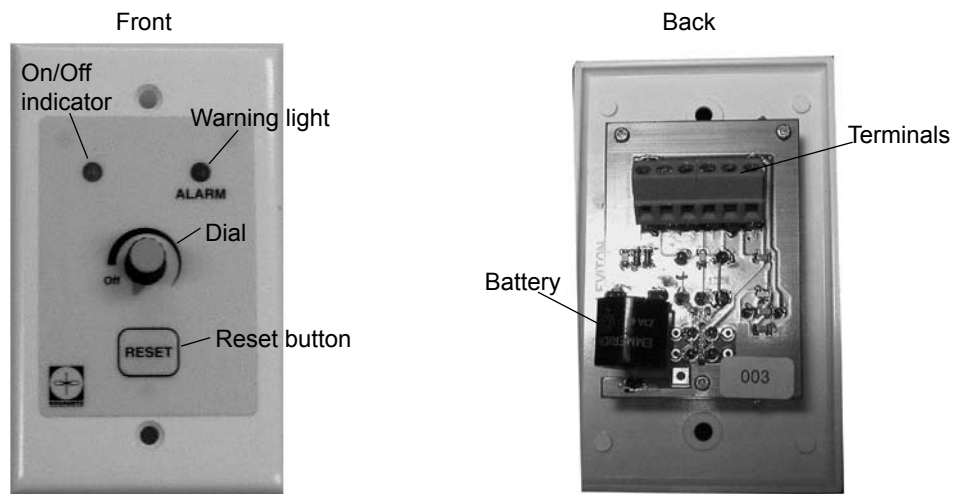

Fig. 2

The speed control unit is used to turn the chimney fan on and off, set the fan speed and monitor the operation. It has indicator lights to confirm operation and to warn in case of malfunctions. The control has an audible alarm that sounds in case of power failure or other failure involving the chimney fan.

The control unit has a rechargeable battery back-up used to operate the control's safety functions.

2. Specifications

2.1 Dimensions & Capacities

Specifications

EFC 211 Main Control Unit		
Power supply	V	1x120VAC
Amperage	A	5.8
Operating temperature	°F/°C	-4 to 122/-20 to 50
Dimensions	A in/mm	4.56/116
	B in/mm	4.56/116
	C in/mm	1.00/25
Weight	lbs/kg	1.3/0.6
EFC 211 Speed Control Unit		
Power supply	V	1x120VAC
Amperage	A	5.8
Operating temperature	°F/°C	-4 to 122/-20 to 50
Output	VAC	10-120
Dimensions	D in/mm	2.73/69
	E in/mm	4.44/113
	F in/mm	0.50/13
	G in/mm	1.00/25
Weight	lbs/kg	1.3/0.6

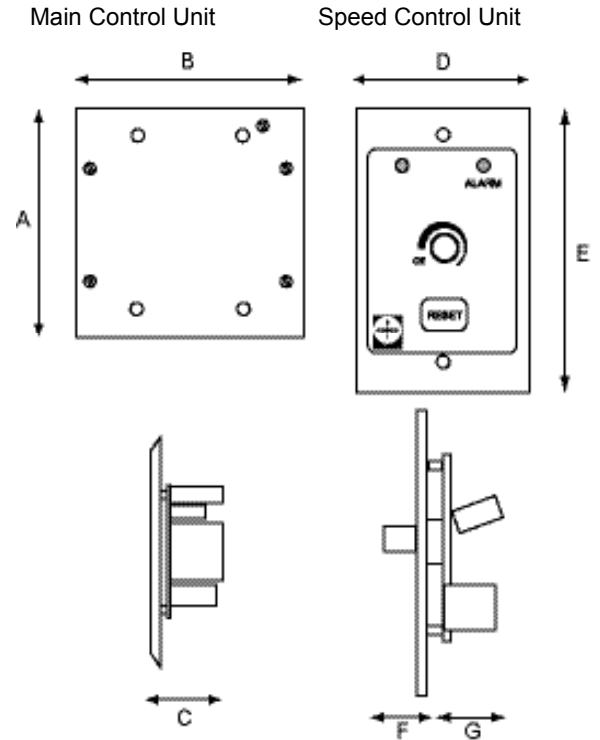

3. Mechanical Installation

3.1 Location

The main control unit can be installed indoors as well as outdoors. It fits a standard 4x4 weatherproof junction box, like the one that is supplied with the chimney fan. An extension ring must be used as shown on fig. 3:

Fig. 3

Show the control taken apart on the side of the chimney



Show the control mounted on side of chimney



The speed control unit can only be installed indoors. It fits a standard 2x4 wall box. See fig. 4

Fig. 4

Show the control taken apart outside the wall box



Show the control mounted on a wall



4. Electrical Installation

4.1 Terminal Connections



Danger: Turn off electrical power before servicing. Contact with live electric components can cause shock or death.



EFC 211 is designed for 1x120VAC power supply only.

The terminals are connected as shown on Fig. 9:

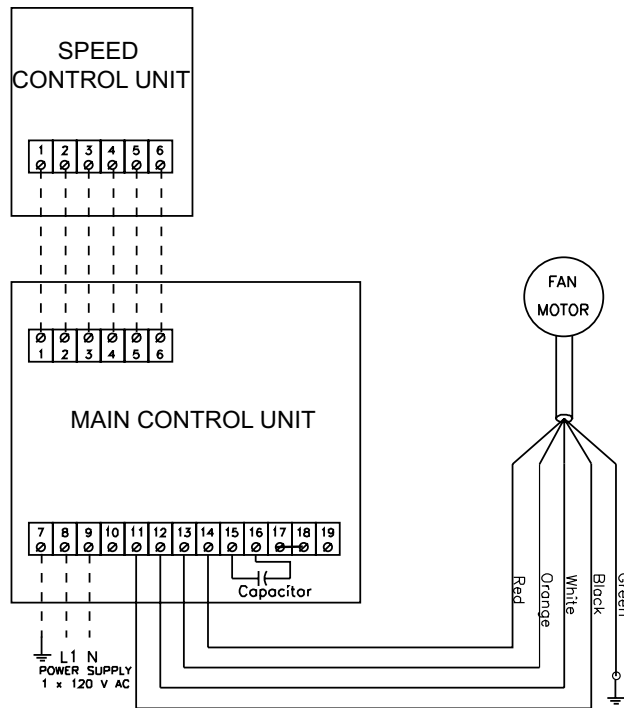

Legend:

- - - - Field Wiring
- Factory Wiring

Fig. 9

5. Startup and Configuration

5.1 Pre-Operation Inspection

After mounting and wiring has been completed, check the control for the following items before applying power:

- Check for wiring errors.
- Verify that there are no wiring chips, screws, etc. remaining inside the junction boxes.
- Check that all screws and terminal connections are tight.
- Verify that no exposed wire ends are touching other terminals.

Apply power to the control. Let the control be turned on for 12 hours to allow the battery to be charged.



Warning: Make sure the battery is fully charged before using the solid-fuel appliance. Failure to charge the battery will prevent the control from provide safe operation.

5.2 Setting the Control

Turn the control on by turning the knob clockwise. A “click” is heard when knob is turned which indicates the control is turned on. Adjust the knob to the desired speed. The speed must be set so no smoke escapes the solid fuel heating appliances (fireplace, stove, wood-fired oven etc.) through the opening into a room. The smoke should safely be exhausted through the chimney.

The chimney fan will start with a 15 seconds boost to assure proper fan operation. The green LED on the speed control unit cover will flash

After the 15 seconds the chimney fan will continue to operate at the desired speed.

During appliance operation the speed setting can be adjusted.

5.3 Surveillance

The control constantly monitors the chimney fan operation. It automatically measures the fan speed every minute and if necessary, it will increase the speed which can be heard as quiet “hick-up” from the fan.

If necessary, the control will increase the speed to full speed for 15 seconds (green LED flashes), after which, if possible, it will slow the fan speed down to the desired speed.

5.4 Alarm Functions

If the green LED flashes during operation (after the 15 seconds initiation) the fan speed is set too low or the fan wheel is somehow obstructed.

If the red LED flashes and the buzzer sounds, it can be caused by:

- Defective chimney fan
- Disconnected power supply

The control can be reset, and the alarm turned off, by pressing the RESET button for 1-2 seconds.

